



Contents

1 About these instructions 1
 2 Description of the solar modules 1
 3 Safety 2
 4 Assembly 2
 5 Electrical connection 3
 6 Maintenance 4
 7 Disclaimer 4
 8 Customer service / Contact 4

1 About these instructions

These instructions contain information about safe handling of KYOCERA solar modules of the KT-series.

They are directed at personnel with electro-technical qualifications and contain safety-relevant instructions for the assembly, connection and maintenance of the solar modules.

IMPORTANT

The solar modules may only be mounted by personnel with electro-technical qualifications. Appropriately qualified technicians must always be deployed to service the units or remedy faults during operation.

Please read these instructions carefully before handling the solar module and familiarise yourself with the safety information. After the module has been installed, hand over these instructions to the operator of the solar modules for safekeeping.

2 Description of the solar modules

2.1 Proper use

The solar modules use the photovoltaic principle to turn light into electricity. The solar modules are primarily designed for connection to an inverter to feed the energy into the public power grid. When connecting to a charge controller, please observe the instructions of the manufacturer of the charge controller and accumulator. Several solar modules can be connected in series or in parallel.

The solar modules may not be directly connected to electrical consumers.

2.2 Description

The solar modules have an aluminium assembly frame with assembly and grounding holes. The solar modules have a junction box and solar cables with plugs for the electrical connection. **Appendix 1** of these instructions contains an illustration of a solar module.

	Designation
①	Grounding holes
②	Junction box
③	Assembly holes
④	Module frame
⑤	Solar cable

The solar modules are equipped with bypass diodes. In the event of clouding, these minimise the losses and help to prevent damage to the solar modules. The solar modules are not equipped with blocking diodes preventing battery discharging at night. Most PV charge regulators incorporate nighttime disconnect feature. The solar modules comply with the application class A in accordance with IEC/EN 61730-1.

2.3 Technical data

Type designation	KT260-6MPA KT260-6MCA	KT265-6MPA KT265-6MCA
Electrical data (at standard test conditions: Irradiation 1000 W/m ² ; air mass AM 1.5; module temperature 25°C)		
P _{max} [W]	260	265
V _{oc} [V]	38.3	38.3
I _{sc} [A]	9.09	9.26
V _{pm} [V]	31.0	31.0
I _{pm} [A]	8.39	8.55
Bypass diode (pre-installed)		
Number	3	
Temperature properties: Temperature coefficient		
V _{oc} [V/°C]	-1.36*10 ⁻¹	-1.36*10 ⁻¹
I _{sc} [A/°C]	5.33*10 ⁻³	5.43*10 ⁻³
P _{max} [W/°C]	-1.18	-1.20
Physical properties:		
Length [mm]	1662	
Width [mm]	990	
Height [mm]	46	
Weight [kg]	19.0	
Assembly holes	Diameter 9 mm , 4 units	
Grounding holes	Diameter 7 mm , 4 units	
Application class	Class A	
Fire class	Class C	
Series fuse rating [A]	15	

3 Safety

Solar modules generate power, producing voltage and current as soon as they are exposed to light. A single solar module generates a voltage of below 50 VDC; if several modules are connected in series, the voltages of the individual modules accumulate and can pose a hazard.



Hazard!

Potentially fatal risk due to electrical shock if damaged solar modules are touched.



- Only touch solar modules with fractured or broken front glass or a damaged rear foil if you are wearing rubber gloves.
- Only touch damaged solar modules if it is absolutely necessary.



Warning!

Risk of falling when working on roofs.

- Use suitable fall protection equipment.
- Observe the accident prevention regulations.



Warning!

Risk of injury from falling objects.

- Cordon off a safe distance around the hazardous zone when working on roofs.



Caution!

To avoid damage to the solar module, please observe the following points:

- Do not apply paint or any adhesives to the rear side of the solar module.
- Never use the junction box or the solar cable to carry the unit.
- When handle the modules, do not hold them by supporting only one side of the long frame.
- Do not expose the solar module to concentrated light.
- Do not allow any objects to fall upon the solar module.
- Avoid scratches to the front glass.

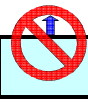

Caution!

Risk of breaking the solar module.



- Do not walk across or step on the solar module.



Caution!

Risk of injury by the solar module frame.

- Do not touch the solar module with bare hands.

NOTE

The frame of the solar module may have sharp edges and may cause injury. Wear suitable gloves, such as leather gloves with padding in the palm and finger areas.

4 Assembly



Assembly work may only be performed by trained and qualified personnel.

4.1 Safety information relating to assembly



Caution!

KYOCERA solar modules are “non-explosion-protected operating equipment”.

- Do not install the solar module close to flammable gases or vapours.



Hazard!

Potentially fatal risk if live parts are touched.

- Cover the solar module with opaque foils or materials during assembly.



Warning!

Risk of falling when working on roofs.

- Use suitable fall protection equipment.
- Do not perform assembly work in strong winds.
- Only perform assembly work in dry weather conditions.
- Observe the accident prevention regulations.

4.2 Select the location

NOTE

Before installing the PV system, contact local authorities to determine the necessary permits, installation and inspection requirements. During assembly, pay attention to the local building standards.

The solar modules can be installed on roofs or open space on support structures. To achieve maximum power yields for feeding into the public grid, the following should be observed when selecting the installation site: The solar irradiation should be as high as possible distributed throughout the year. To this end, the surface of the solar modules in the northern hemisphere must face south. In Europe, the ideal module slope is approx. 30° - 40°. While a bigger module slope leads to energy losses, smaller module slope can also lead to high accumulations of non-slipping snow on the module, which might cause damages to the module or its frame. Install the solar modules where they are not shaded by obstacles such as buildings or vegetation. Pay special attention to avoid partial shadowing of the solar modules by close-by objects. The solar modules should not be installed in the area with direct exposure to saltwater droplet (Guideline : within 50 m of a saltwater body). In the zone between 50 m and 200 m from a saltwater body, the PV modules should be installed as roof mounted only. For more information about the selection of the site, please contact the KYOCERA customer service.

4.3 Preparatory work for assembly

The solar module must be mounted to a support structure. Please observe the information provided by the mount manufacturer when selecting the support structure. If installed on a roof, the solar modules must be mounted on a fire-resistant surface.

4.4 Mounting the solar module

Please observe the following during assembly:

- A clearance of at least 50 mm needs to be kept between the module frame and the attachment surface. This allows the cool ambient air to circulate below the solar module. This is necessary for optimum performance in all application ranges.
- There should be a clearance of at least 3.2 mm between the individual module frames to allow heat-related expansion.
- The solar modules can be installed in either portrait or landscape position.
- If high accumulations of snow on the module array occur on site, the lower part of the module frames could be damaged when slipping snow is piled up there. This kind of damage needs to be avoided by an appropriate countermeasure e. g. attaching support parts at the lower side frames of the modules.
- When selecting the material for the support structure, pay attention to the electrochemical series in order to avoid galvanic corrosion between different kinds of metal.
- Fasten modules firmly to a support structure designed to withstand the local wind and snow loads
- The glass surface may have color variations depending on the viewing angle or installation circumstance. This is a normal characteristic of the glass and doesn't affect the quality of the solar module. Do not touch the glass surface with bare hand to avoid contamination. Clean the glass surface with a soft wet cloth without detergent if it is contaminated with oil or fingerprints. Do not rub the glass surface with something hard like a metal or sharp edge.

4.4.1 Bolting

Assembly material

- Stainless steel screws, diameter 8 mm (4 units)
- Screw body length is 25.4mm or less.
- Nuts with locking teeth (4 units)

NOTE

No holes may be drilled into the module frame.

Procedure

- ✓ Please see the drawing in Appendix 1 of these instructions for the positions of the mounting holes.
- ✓ Drill the required assembly holes to the support structure.
- ✓ Tighten the screws with adequate torque (usually 12.5 Nm) to securely attach the solar module to the supporting frame. As adequate torque figure depends on selected bolt nuts, follow the manufacturers' recommended numbers.

4.4.2 Clamps

Assembly material

- Rustproof module clamps (at least 4 units).
- Please observe the information provided by the manufacturer when selecting the clamps.

Installation with long side of frame

- must be at least 24mm long respectively.
- must overlap the module frame by at least 5mm.

Installation with short side of frame

- must be at least 24mm long respectively.
- must overlap the module frame by at least 9mm.

NOTE

The module clamps or insertion system

- must not bend the module frame.
- must not touch the front glass.
- must not cast a shadow on the front glass.
- must not damage the surface of the frame.

Procedure

- ✓ Define the positions of the clamps based on the drawings in **Appendix 2**.
- ✓ Tighten the module clamps to the torque stated by the clamp manufacturer.
- ✓ Fasten modules firmly by clamps designed to withstand the local wind and snow loads.

4.4.3 Assembly to insertion system

When mounting the modules to an insertion system, follow the instructions in the drawings in **Appendix 2**. Please observe the information provided by the manufacturer.

The insertion system must overlap the module frame by at least 7mm.

NOTE

Take measures to prevent module from moving or falling off. (e. g. put spacer parts into clearance between module frame and mounting rail.)

5 Electrical connection



Only specially trained and qualified personnel may make the electrical connection.

5.1 Safety information relating to the electrical connection

Hazard!

Potentially fatal risk if live parts are touched.

- Never disconnect or connect electrical contacts when under load.
- Only use dry, insulated tools for the electrical assembly work.
- Never touch live parts with bare hands.
- Cover the solar module during installation with opaque foils or materials.
- Do not wear any metal jewellery.



5.2 Wiring of the solar modules

NOTE

The maximum system voltage of solar modules connected to each other may not exceed 1000 VDC. When designing the system, please note that the module voltage increases when the temperatures are low. Do not connect the modules in parallel without max. over current protection.

Under normal conditions, solar modules can supply higher currents and/or a higher voltage than reported at the standard test conditions (**see chapter 2.3 "Technical Data"**).

Therefore, when determining component voltage ratings, conductor current ratings, fuse sizes, and the size of controls connected to the output of the solar modules, the stipulated values of I_{SC} and V_{OC} should be multiplied with a factor of 1.25. Only interconnect modules of the same type within a system.

The solar modules are equipped ex-works with 4 mm²-solar cables. The solar cables have SMK R51-7/P51-7 connectors. These connectors are designed for series wiring only. Always use special solar cables with a minimum conductor size of 4 mm² and suitable PV-connectors for further series or parallel wiring.

When wiring, proceed as follows:

- Ensure the poles are connected correctly and that the plugs are connected properly without gaps
- Observe the minimum bending radius of 24.5 mm of the solar cables that are used.
- Plug and socket connections shall only be mated with those of the same type from the same manufacturer.

5.3 Connection of the solar modules

Please observe the information provided by the manufacturer of the inverter when connecting the solar modules to an inverter.

5.4 Grounding of the solar modules

To minimise the risk of an electrical shock, the frames of the solar modules should be grounded.

Assembly material

- stainless steel screw, diameter 6 mm with serrated washer and nut
- suitable grounding cable

NOTE

Ensure that the anodised layer of the frame is penetrated and a secure electrical contact is created with the frame.

Procedure

- ✓ Please see the drawing in **Appendix 1** of these instructions for the positions of the grounding holes.
- ✓ Screw the grounding cable firmly to one of the grounding holes using the stainless steel screw and a min. torque of 8 Nm.

6 Maintenance



Only specially trained and qualified personnel may service the solar system.

KYOCERA solar modules are designed for long-term service and are almost maintenance-free.

6.1 Safety information relevant for maintenance



Warning!

Risk of falling when working on roofs.

- Use suitable fall protection equipment.
- Observe the accident prevention regulations.

6.2 Cleaning the solar module

When the slope is adequate (> 15 degrees), the solar modules do not need to be cleaned thanks to the self-cleaning effect of the rain. If heavily soiled, clean with plenty of water, a mild detergent and a soft cloth/sponge.

6.3 Solar module maintenance

The system should be inspected once a year with regard to the following:

- Secure hold and no rust on any of the attachments
- Secure connection, cleanliness and that all cable connections are free of corrosion
- Soundness of cables and front glass

7 Disclaimer

KYOCERA's "Limited Warranty for Photovoltaic-Modules" does not apply if this assembly and maintenance instruction is not strictly observed. KYOCERA will not assume any liability for damage arising from improper use, wrong assembly, operation or maintenance.

8 Customer service / Contact

KYOCERA Fin ceramics GmbH

Solar Division
Fritz-Mueller-Strasse 27
D-73730 Esslingen / Germany

Tel: +49 (0)711-93934-998

Fax: +49 (0)711-93934-861

E-Mail: pv-support@kyocera.de

You will find more information and the latest data sheets, warranty conditions, certificates etc. in the download section of our website: www.kyocerasolar.eu

Please contact us if you need more information that is not provided in our website.

Appendix 1

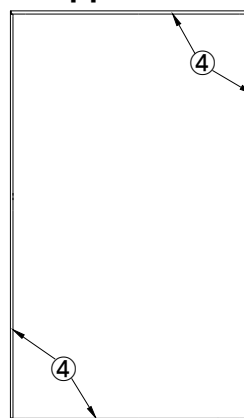

- ① Grounding holes
- ② Junction box
- ③ Assembly holes
- ④ Module frame
- ⑤ Solar cable

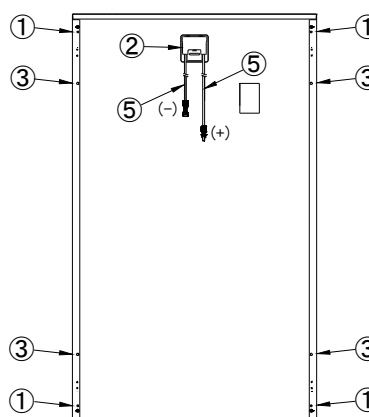



KTxxx-6MPA
KTxxx-6MCA

Installation with long side frame
Befestigung an der langen Rahmenseite
Fixation sur la partie longue du cadre
Fissaggio sul lato lungo del telaio
Upevnění na dlouhé straně rámu

Mounting table A-1
Montagetabelle A-1
Tableau de montage A-1
Tabella di montaggio A-1
Montážní tabulka A-1





	2400Pa		5400Pa	
Bolting Verschrauben Vissage Fissaggio a vite Příšroubování				
Clamping Klemmen Connexion Fissaggio con morsetti Svorky				
insertion system Einlegesystem système de fixation sistemi di fissaggio systém na vložení				
insertion system mounting-bar Einlegesystem montage-barre système de fixation montage-barre sistemi di fissaggio montaggio-barre systém na vložení montáž-bar				



KTxxx-6MPA
KTxxx-6MCA

Installation with short side frame
Befestigung an der kurzen Rahmenseite
Fixation sur la partie courte du cadre
Fissaggio sul lato corto del telaio
Upevnění na krátké straně rámu

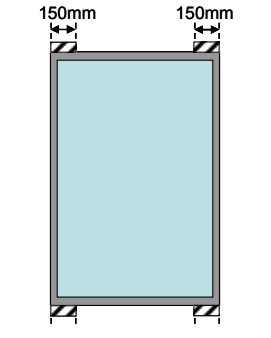
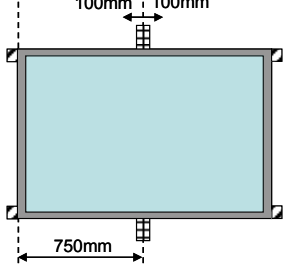
Mounting table A-2
Montagetabelle A-2
Tableau de montage A-2
Tabella di montaggio A-2
Montážní tabulka A-2

	2400Pa		5400Pa
<p>Clamping Klemmen Connexion Fissaggio con morsetti Svorky</p> <p> : Permissible clamping range Zulässiger Klemmbereich Plage de connexion admise Area di bloccaggio consentita Přípustná oblast upnutí</p> <p> : Support rack Unterstützung Renfort Supporto Podpěra</p>			
<p>insertion system Einlegesystem système de fixation sistemi di fissaggio system na vložení</p> <p> : insertion system mounting-bar Einlegesystem montage-bar système de fixation montage-barre sistemi di fissaggio montaggio-bar system na vložení montáž-bar</p> <p> : Support rack Unterstützung Renfort Supporto Podpěra</p>	